

Introduction to Refrigeration and Air conditioning

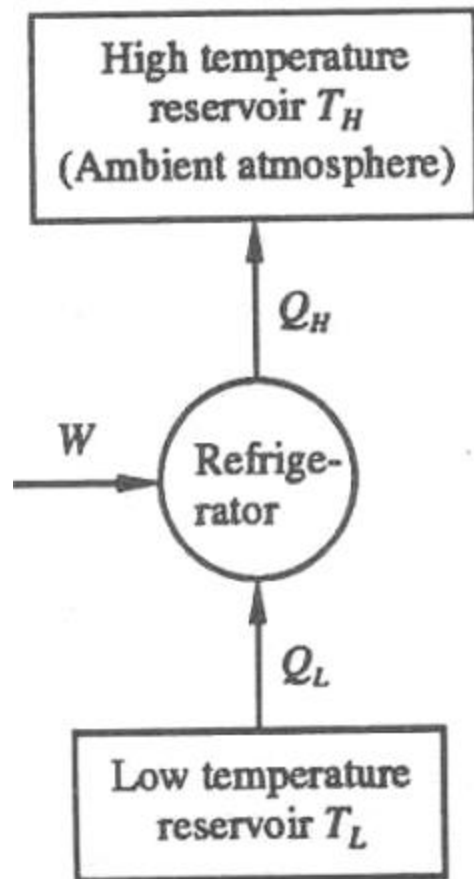

**"The Bosmans' wedding announcement?
Stick it on the fridge so we
don't forget about it."**

- **Refrigeration** is a process of achieving and maintaining a low temperature below that of surroundings



Which of the following can be called as a refrigeration process??

- a) Cooling of hot ingot from 1000°C to room temp
- b) Cooling of a pot of water by mixing it with a large block of ice
- c) Cooling of human beings using a ceiling fan
- d) Cooling of hot water by mixing it with tap water
- e) Cooling of water by creating vacuum over it
- f) Cooling of a hot cup of coffee by leaving it on a table

SYLLUBUS

MODULE 1

- Introduction – Brief history and applications of refrigeration. Thermodynamics of refrigeration - reversed Carnot cycle - heat pump and refrigeration machines, Limitations of reversed Carnot cycle. Unit of refrigeration.
- Air refrigeration systems - Reversed Joule cycle, Air craft refrigeration systems, simple bootstrap - Regenerative and reduced ambient system.

MODULE 2

- Vortex tube refrigeration - Very low temperature refrigeration systems (concept only). Adiabatic demagnetization of paramagnetic salts.
- Vapour compression systems-simple cycle - representation on T-S and P-H Diagrams. COP - Effect of operating parameters on COP - methods of improving COP of simple cycle- super heating, under cooling, Liquid suction heat exchanger, actual cycle.

MODULE 3

- Multi pressure systems - multi compression and multi evaporator systems. Inter cooling - flash inter cooling and flash gas removal. Different combinations of evaporator and compressor for different applications. Cascade system.
- Refrigerants and their properties-Eco-friendly Refrigerants, mixed refrigerants, selection of refrigerants for different applications.
- Vapour absorption systems - Ammonia – water system - simple system- drawbacks-Lithium Bromide water system- Electrolux- comparison with vapour compression system- steam jet refrigeration.

MODULE 4

- Application of refrigeration - domestic refrigerators - water coolers - ice plants. Cold storages - food preservation methods - plate freezing, quick - freezing.
- Refrigeration system components - Compressors, condensers, expansion devices, evaporators. Cooling towers - Different types and their application fields. Refrigerant leakage and detection - charging of refrigerant - system controls.

MODULE 5

- Air conditioning - meaning and utility, comfort and industrial air conditioning. Psychrometric properties - saturated and unsaturated air, dry, wet and dew point temperature - humidity, specific humidity, absolute humidity, relative humidity and degree of saturation- thermodynamic equations- enthalpy of moisture- adiabatic saturation process - Psychrometers. Thermodynamic wet bulb temperature, Psychrometric chart- Psychrometric processes- adiabatic mixing - sensible heating and cooling - humidifying and dehumidifying, Air washer - bypass factor - sensible heat factor - RSHF and GSHF line - Design condition - Apparent dew point temperature. Choice of supply condition, state and mass rate of dehumidified air quantity - Fresh air supplied - air refrigeration.
- Comfort air conditioning - factors affecting human comfort. Effective temperature - comfort chart. Summer air conditioning - factors affecting - cooling load estimation.

MODULE 6

- Air conditioning systems - room air conditioner - split system - packaged system - all air system - chilled water system. Winter air conditioning - factors affecting heating system, humidifiers. Year round air conditioning. AC system controls - thermostat and humidistat.
- Air distribution systems - duct system and design - Air conditioning of restaurants, hospitals, retail outlets, computer center, cinema theatre, and other place of amusement. Industrial applications of air conditioning.

TEXT/REFERENCE BOOKS

T/R	BOOK TITLE/AUTHORS/PUBLICATION
T1	Arora C. P, Refrigeration and Air-Conditioning, McGraw-Hill, 2008
T2	Arora S. C. and Domkundwar, Refrigeration and Air-Conditioning, Dhanpat Rai, 2010
T3	Ballaney P. L, Refrigeration and Air-Conditioning, Khanna Publishers, New Delhi, 2014
T4	Manohar Prasad, Refrigeration and Air-Conditioning, New Age International, 2011
R1	Stoecker W. F, Refrigeration and Air-Conditioning, McGraw-Hill Publishing Company, 2009
R2	Dossat. R. J, Principles of Refrigeration, Pearson Education India, 2002
R3	ASHRAE Handbook
R4	Robert H. Enerick, <i>Basic Refrigeration and Air-Conditioning</i> , Prentice Hall.

COURSE OUTCOMES

To **identify** and **compare** different type of refrigerating machines used in industries and in other establishments.

To **analyze** the influence of all operating parameters of R & AC machines & can **select** the right refrigerating equipment for a particular application.

To **select** the right refrigerant for a particular practical situation. **Apply** their knowledge in unconventional refrigeration methods and working principles of refrigerating and air conditioning equipment to attain sustainable refrigeration methods.

To **select** the right type of components for a particular refrigerating / air conditioning system used in practice.

Using the principles of air conditioning, students will be able to **design** different type of air conditioning systems and duct systems for industrial applications.

HISTORY

- The seasonal harvesting of snow and ice is an ancient practice estimated to have begun earlier than 1000 B.C
- The Jews, the Greeks, Romans and the Egyptians did not use ice and snow to preserve food, but primarily as a means to cool beverages.



- 500 BC – The **Yakhchal** (meaning "ice pit" in Persian) is an ancient Persian type of refrigerator.
- The structure was built of a water resistant mortar called SAROOJ, that is resistant to heat transfer, in the shape of a dome above the ground.
- It was often used to store ice, but sometimes was used to store food as well.

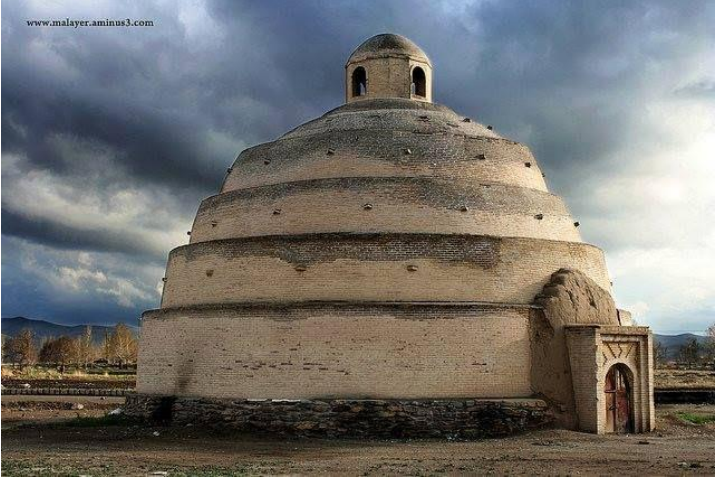

- Ice houses are buildings used to store ice packed with insulation, often straw or sawdust.
- Ice House would be near a river or stream, and deep in the ground to maximize refrigeration.

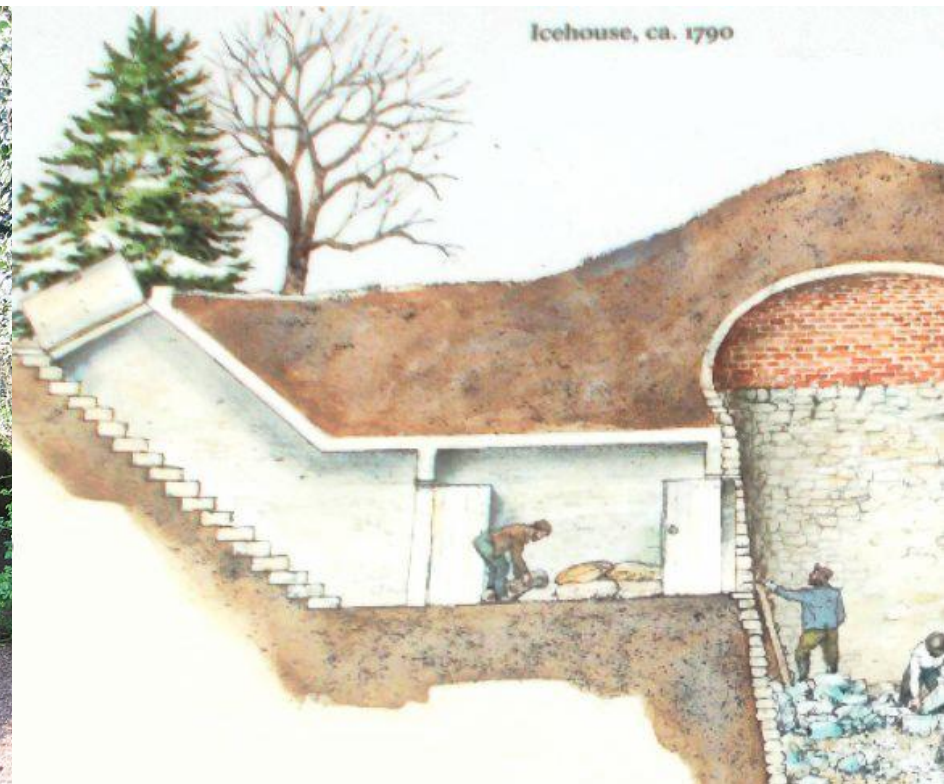

- The **ice trade**, also known as **the frozen water trade**, was a 19th-century industry, centering on the east coast of the United States and Norway, involving the large-scale **harvesting, transport and sale of natural ice** for domestic consumption and commercial purposes.
- In 1806, **Frederic Tudor**, (later called as the “**Ice King**”) begun the trade in ice by cutting it from Hudson River and exports it.



- Most Ice Boxes were made of wood with an interior lined with tin, cork or zinc. Many people used sawdust or seaweed to help keep their blocks of ice cooler, longer.
- Because the ice would eventually melt, a drip tray was placed underneath the icebox to catch melt. The tray had to be frequently emptied.



Ice making by Nocturnal Cooling

- Ice was made by keeping a thin layer of water in a shallow earthen tray, and then exposing the tray to the night sky.
- The water loses heat by radiation to the Stratosphere, which is at around -55°C and by early morning hours the water freezes to ice.
- This method of ice production was very popular in India.

Evaporative cooling



Artificial Refrigeration

- Scottish professor **William Cullen** designed a small refrigerating machine in 1755.
- Cullen used a pump to create a partial vacuum over a container of diethyl ether, which then boiled, absorbing heat from the water which is in thermal contact.
- Vapor pressure & Latent heat

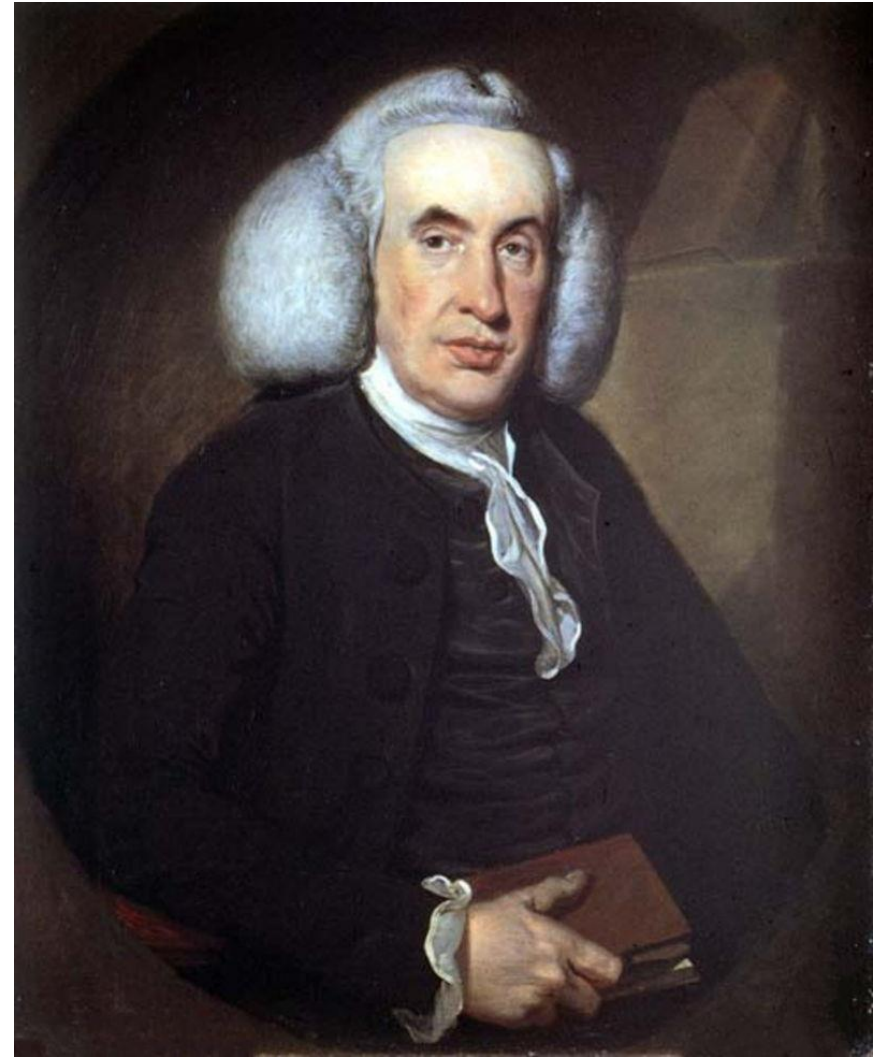



JACOB PERKINS.

Jacob Perkins (9 July 1766 – 30 July 1849) was an American inventor, mechanical engineer and physicist. Born in Newburyport, Massachusetts. Perkins had 21 American and 19 English patents.

- Perkins is credited with the first patent for the vapor-compression refrigeration cycle, assigned on August 14, 1835 and titled, "**Apparatus and means for producing ice, and in cooling fluids**".
- The idea had come from another American inventor, **Oliver Evans**, who conceived of the idea in 1805 but never built a refrigerator.
- The same patent was granted in both Scotland and England separately.

Perkins' prototype wasn't commercially successful.

John Hague made it into working model.



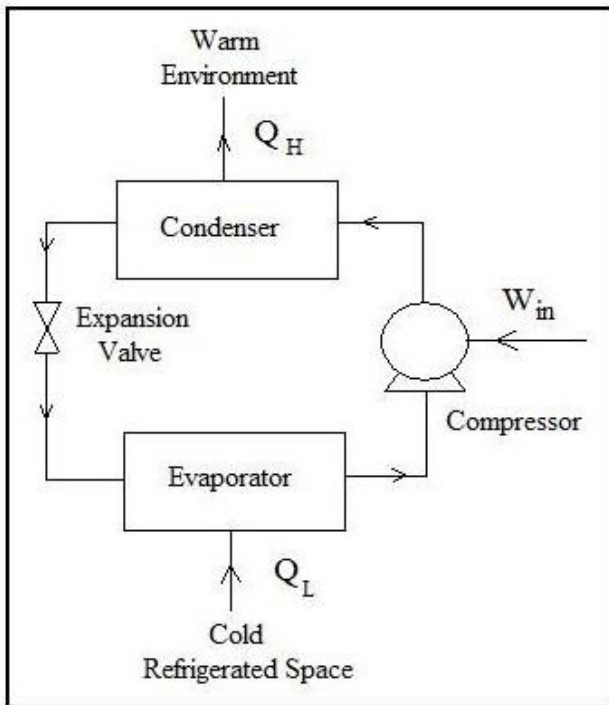
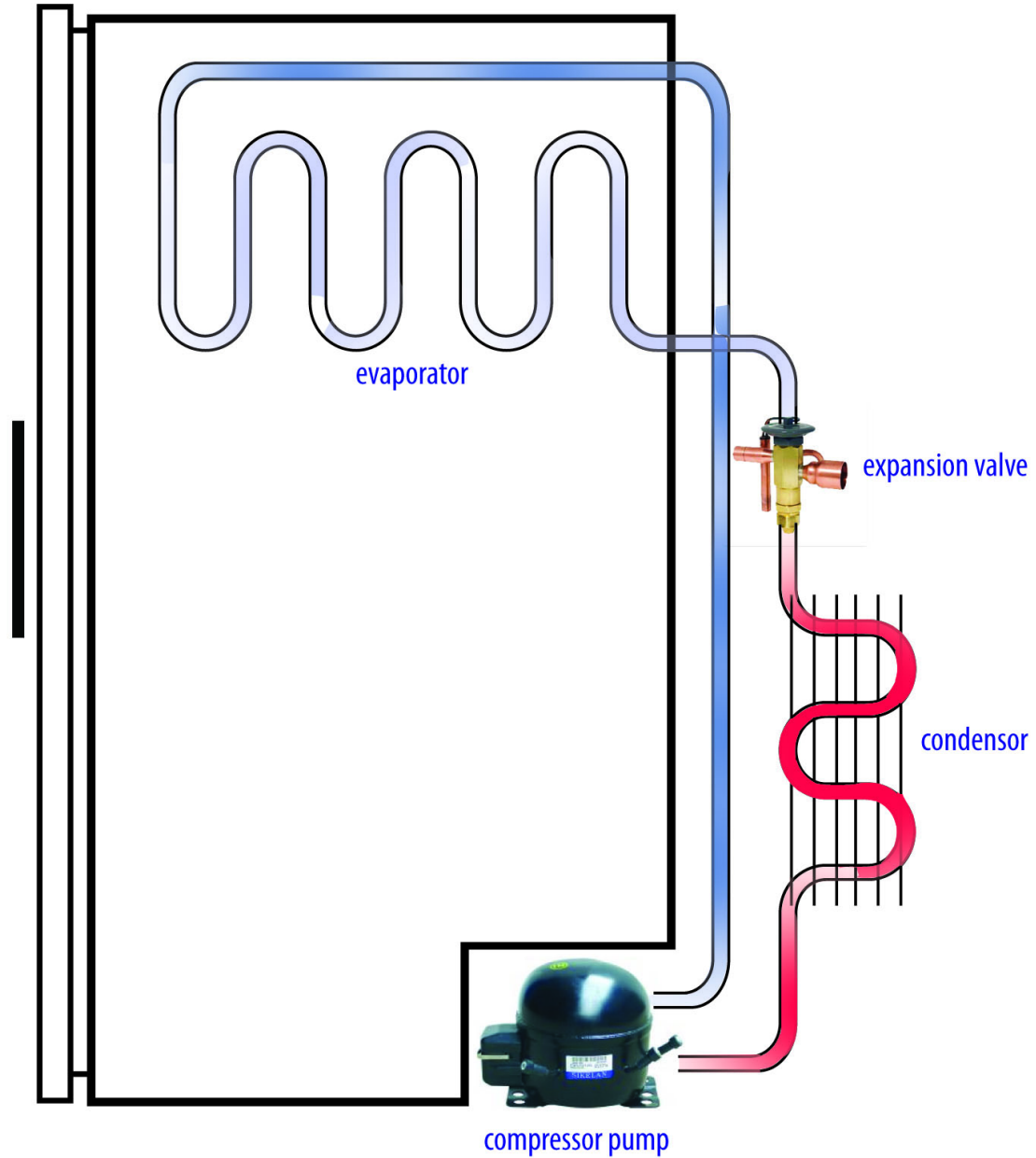

Vapor Compression Refrigeration Cycle

- **John Gorrie** (October 3, 1802 – June 29, 1855) was a physician, scientist, inventor, and humanitarian
- He received his medical education at the College of Physicians and Surgeons of the Western District of New York in Fairfield.
- After 1845, he gave up his medical practice to pursue refrigeration projects. On May 6, 1851, Gorrie was granted Patent No. 8080 for a machine to make ice.

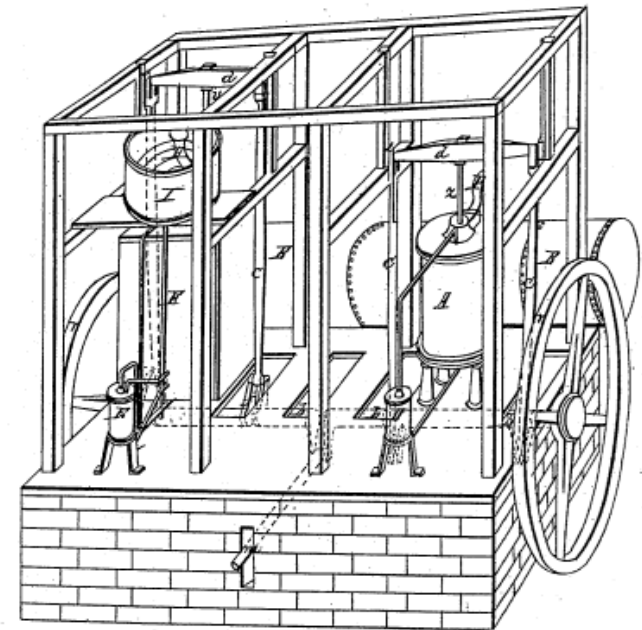

The Electric Refrigerator

- While the use of the Ice Box lasted into the 20's & '30's, an alternate form of refrigeration was introduced during this time. It was an electric refrigerator with a cooling unit on top.

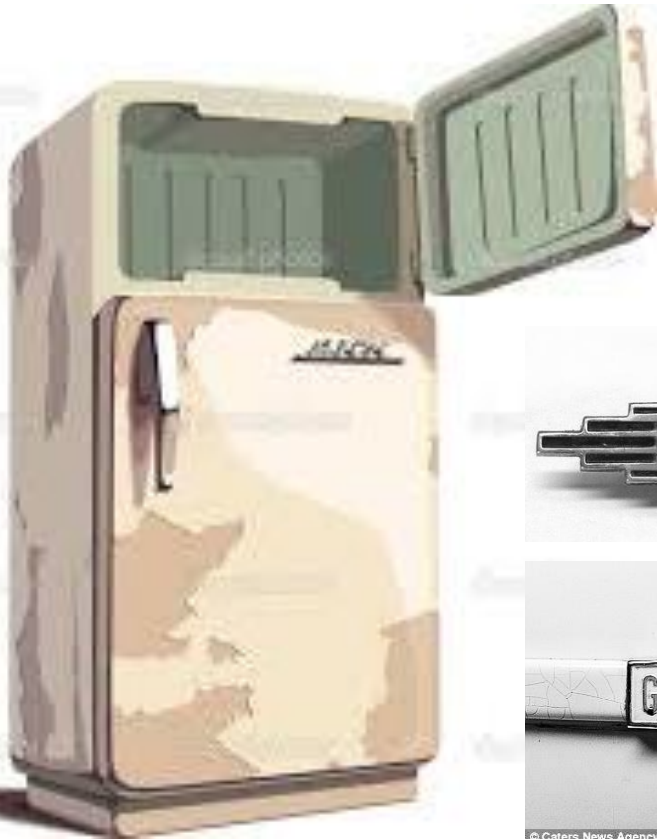

Cooking with Cold

The secret of the delicious
meats—"roasting" by
the medium of Kelvinator Elec-
tric Refrigeration—is estab-
lished practice in hundreds
of Australian homes.
There are scores of deli-
cious summer dishes—soups,

dilled cucumbers and salads,
soups, ices and beverages
—which require Kelvinator's
dependable cold in the
preparation; and, of course,
Kelvinator gives reliable
food-protection in all
seasons.

Kelvinator

Austalia Limited
802ND HIGHWAY, GEORGETOWN

FRIGIDAIRE

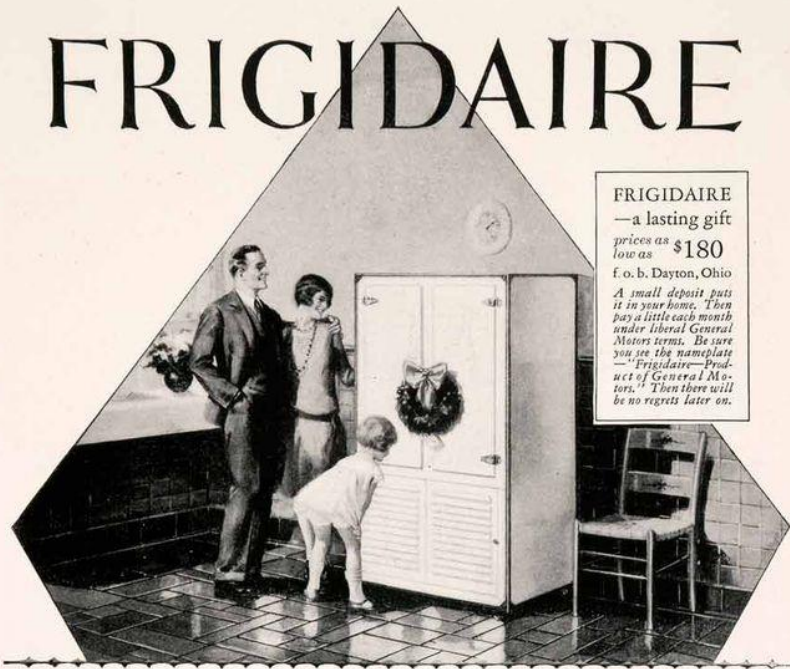

FRIGIDAIRE
—a lasting gift

prices as
low as \$180
f. o. b. Dayton, Ohio

A small deposit puts
it in your home. Then
pay a little each month
under liberal General
Motors terms. Be sure
you see the nameplate
—Frigidaire—Pro-
duct of General Mo-
tors. Then there will
be no regrets later on.

Give her a *real* thrill this Christmas!

With a gift of a Frigidaire

Use part of your Christmas savings to cover the first small payment!

Of course, she's a regular fellow and will like whatever you give her. But here's a chance to do something handsome and provide a *real* Christmas thrill!

It's so easy. The price of a few Christmas knick-knacks will put a Frigidaire Electric Refrigerator in your home. Think of it! A gift that lasts for many years to come. A gift that she'll use every day in the

year. A gift that's a constant reminder of what a good fellow you are.

Forego the usual last-minute shopping this Christmas. Avoid the hurrying crowds. Spend a few leisurely moments in a nearby Frigidaire Sales Room. When you leave, the stage will be set for a Christmas she'll remember for years.

So don't hold back at Christmas time. Do the handsome thing this year. But *do it now*—while Frigidaire Distributors can still promise Christmas deliveries.

Frigidaire, by all standards of comparison, costs less than any other electric refrigerator nationally distributed.

FRIGIDAIRE CORP.
Subsidiary of General Motors Corporation
Dept. Y-309, Dayton, Ohio

A PRODUCT OF GENERAL MOTORS

A New
GENERAL ELECTRIC REFRIGERATOR
will use 40% Less Current!



HOOOT MON! A new G-E Refrigerator in the kitchen is a grand way of saving more money! General Electrics are now even thrifter than ever.

Long famous for dependable performance at low cost, the "ageless" G-E sealed-in-steel mechanism now gives you "double the cold" and uses 40% less current.

See the new, distinctively styled 1936 General Electric models now on display. Have one in your kitchen this spring. It will save you money every month and you will have all these modern convenience features to enjoy:

Stainless steel super-freezer. Sliding shelves. Automatic interior light. Foot-pedal door opener. Temperature control. Defrosting



switch. Vegetable drawer. Chiller tray. Matched food containers.

There is a G-E Monitor, Flatop or Liftop model that will exactly meet your requirements. Each has the matchless G-E sealed-in-steel mechanism that requires no attention, not even oiling. Prices as low as \$79.50 f. o. b.

For your nearest G-E dealer see "Refrigerators—Electric" in the classified pages of your telephone book. General Electric Company, Specialty Appliance Department, Section G-4, Nela Park, Cleveland, Ohio.

GENERAL ELECTRIC
ALL-STEEL REFRIGERATORS

DOMESTIC, APARTMENT HOUSE AND COMMERCIAL REFRIGERATORS, ELECTRIC WATER COOLERS

Hotpoint gives you more refrigerator than you pay for.



Big, family-size Hotpoint Refrigerator with extras most refrigerators don't have.

The 17.6 cubic-foot refrigerator gives you extras like our new Easy Release Ice Tray that you just flip over and watch to get ice cubes. And overhead shelves that adjust up or down to fit whatever you're storing. And shelves, for easy cleaning, break out and behind it. And it's totally ice-free, with about 23 pounds more food space than other refrigerators the size (30 1/2 inches). You get all this, and much more. Model C7909RC.



WITH THE LG DOOR-IN-DOOR REFRIGERATOR LIFE'S MORE CONVENIENT

Introducing the LG Signature Door-in-Door Refrigerator. It's the French Door with more. It has the largest capacity in its class, and a unique door-in-door design that gives you easy access to all the things you use most. It's the dream fridge for everyone, only from LG.

Model Number GR-D907SL
Georgia Parker - Award winning actor



Linear Compressor

Linear Compressor - makes it quiet



LG

Life's Good



Can you use a
refrigerator to
cool the room?

AIR CYCLE REFRIGERATION SYSTEMS

ASSUMPTIONS

- The working fluid is a fixed mass of air that behaves as an ideal gas.
- The cycle is assumed to be a closed loop cycle.
- All the processes within the cycle are reversible.
- The specific heat of air remains constant throughout the cycle.

Reversed Carnot cycle

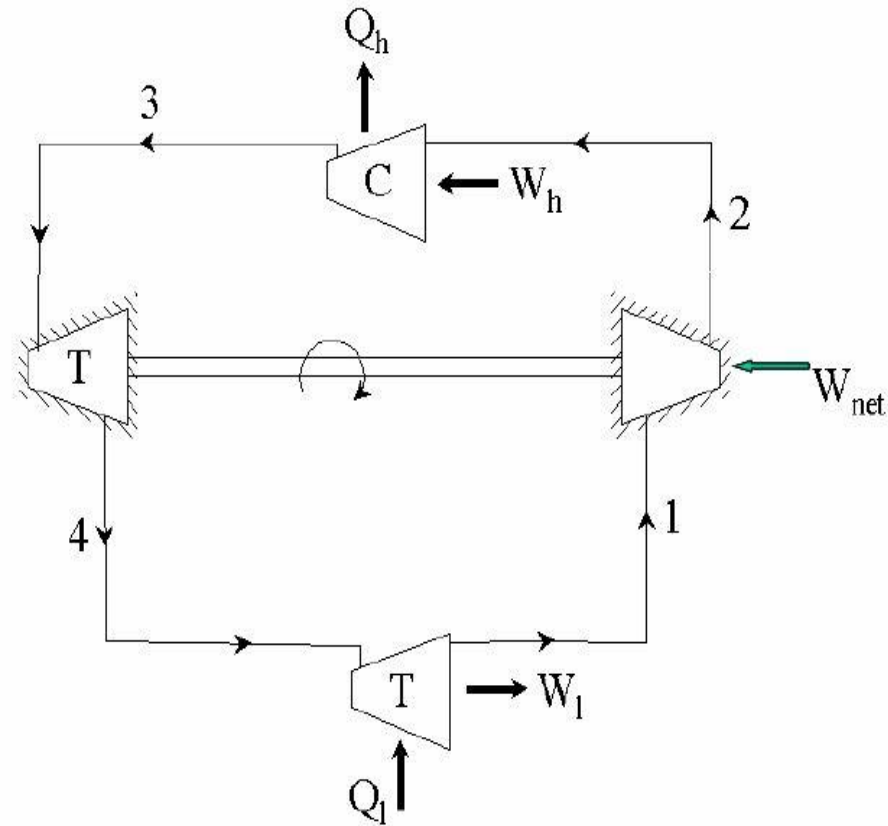
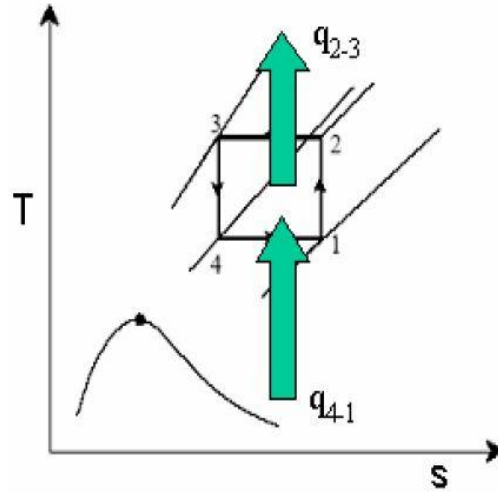
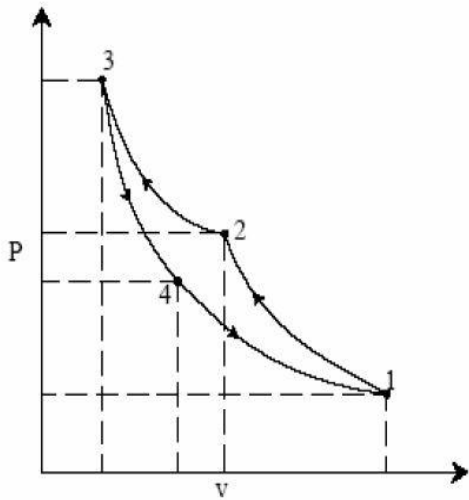

Reverse Carnot gas cycle

- Ideal cycle for constant temperature heat source and sink
- It is a completely reversible cycle
- COP is a function of high and low temperatures only

Limitations:

- Isothermal compression and expansion are difficult to achieve in practice
- Small volumetric refrigeration capacity
- \Rightarrow High volumetric flow rates of air

Ideal reverse Brayton cycle (Joule or Bell-Coleman cycle)

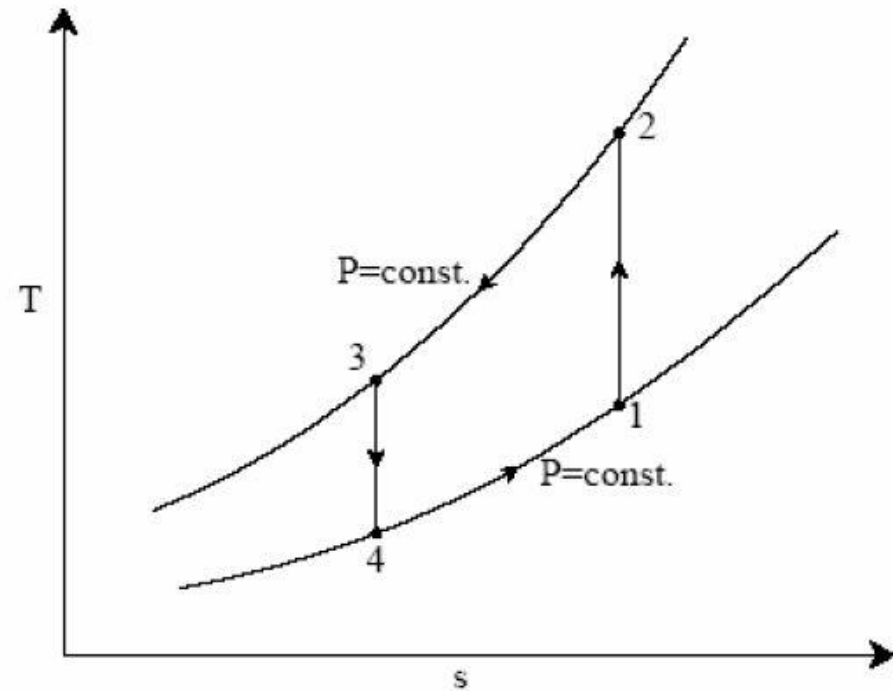
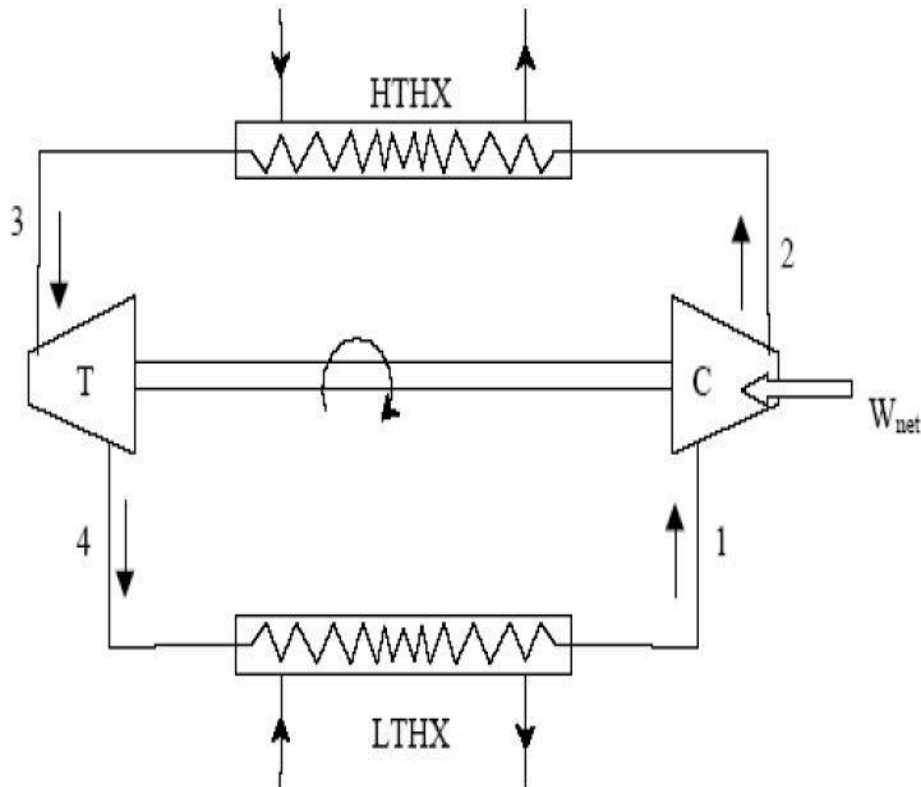

- Process 1-2: Reversible, adiabatic compression in a compressor
- Process 2-3: Reversible, isobaric heat rejection in a heat exchanger
- Process 3-4: Reversible, adiabatic expansion in a turbine
- Process 4-1: Reversible, isobaric heat absorption in a heat exchanger

- For fixed heat rejection temperature (T_3) and fixed refrigeration temperature (T_1), the COP of reverse Brayton cycle is always lower than the COP of reverse Carnot cycle.

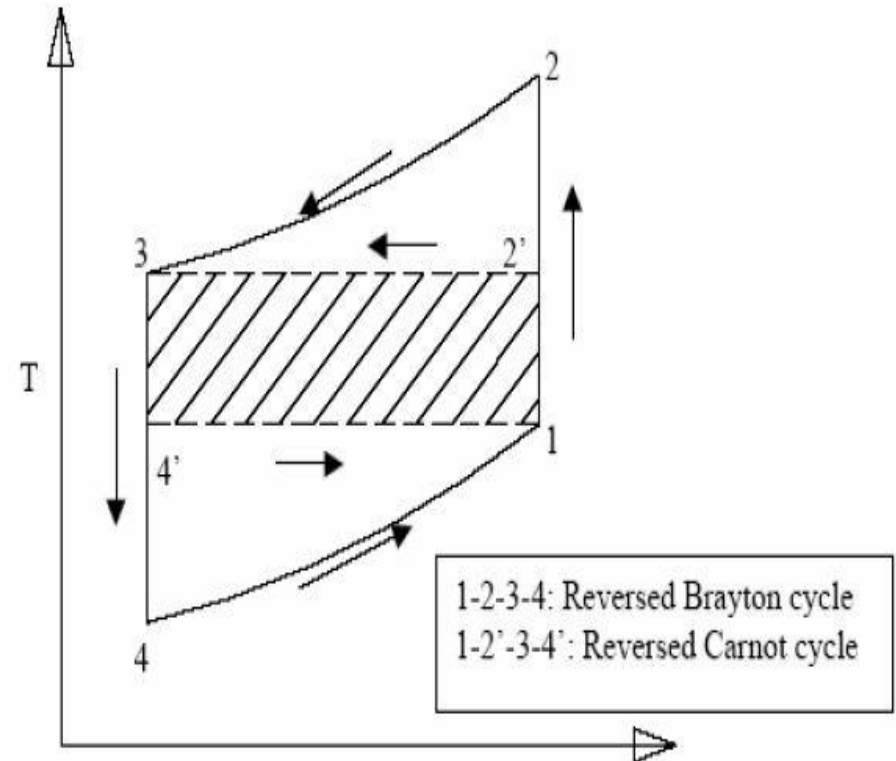

$$\text{COP}_{\text{Brayton}} = \left(\frac{T_4}{T_3 - T_4} \right) < \text{COP}_{\text{Carnot}} = \left(\frac{T_1}{T_3 - T_1} \right)$$

Actual reverse Brayton cycle

- The actual reverse Brayton cycle differs from the ideal cycle due to:
 - a) Non-isentropic compression and expansion processes
 - b) Pressure drops in cold and hot heat exchangers

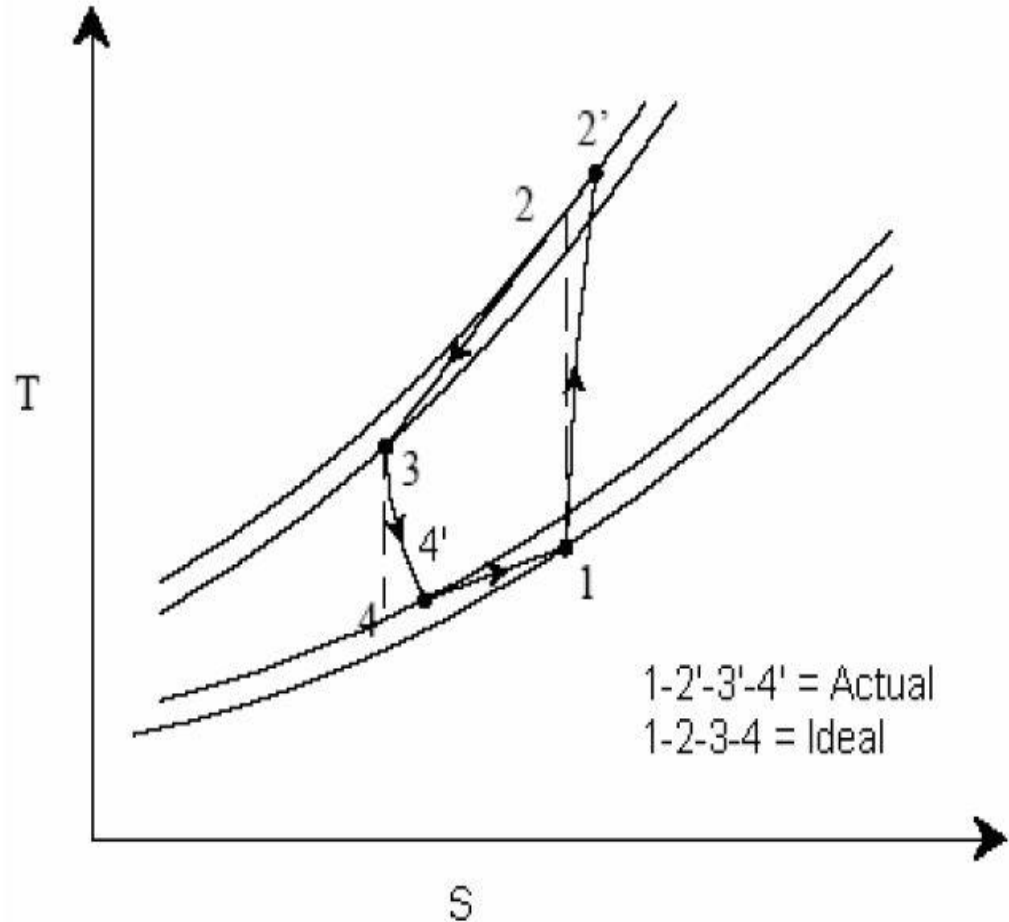

- The net work input increases due to increase in compressor work input and reduction in turbine work output.
- The refrigeration effect also reduces due to the irreversibilities.
- As a result, the **COP of actual reverse Brayton cycles will be considerably lower than the ideal cycles.**
- Design of efficient compressors and turbines plays a major role in improving the COP of the system.

TWO TYPES

Open systems

- Cold air at the exit of the turbine flows into a room or cabin and cold HX doesn't exist.
- Will take fresh air for next cycle.
- In such a case, the low side pressure will be atmospheric.

Closed systems

- The same gas (air) flows through the cycle.
- Low side pressure can be **above atmospheric.**
- These systems are known as *dense air systems.*
- Gases other than air (e.g. helium) can be used.

Aircraft cooling systems

Why cooling systems in Aircraft???

- Large internal heat generation due to occupants, equipment etc.
- Heat generation due to skin friction caused by the fast moving aircraft
- Ram effect
- Solar radiation

Air cycle refrigeration systems are preferred in Aircrafts. Why???

- Air is cheap, safe, non-toxic and non-flammable. Leakage of air is not a problem.
- Cold air can directly be used for cooling thus eliminating the low temperature heat exchanger (open systems) leading to lower weight.
- Main compressor of the aircraft itself can be used for compression.
- Design and maintenance are simpler.

Different Types

1. Simple system
2. Bootstrap system
3. Regenerative system
4. Reduced ambient system

Simple aircraft refrigeration cycle

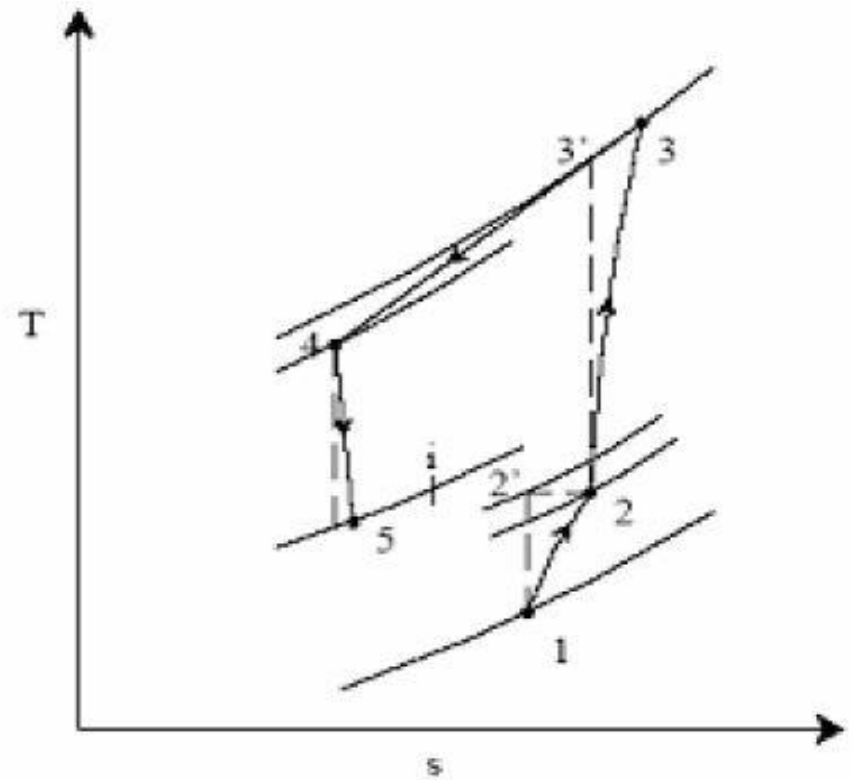
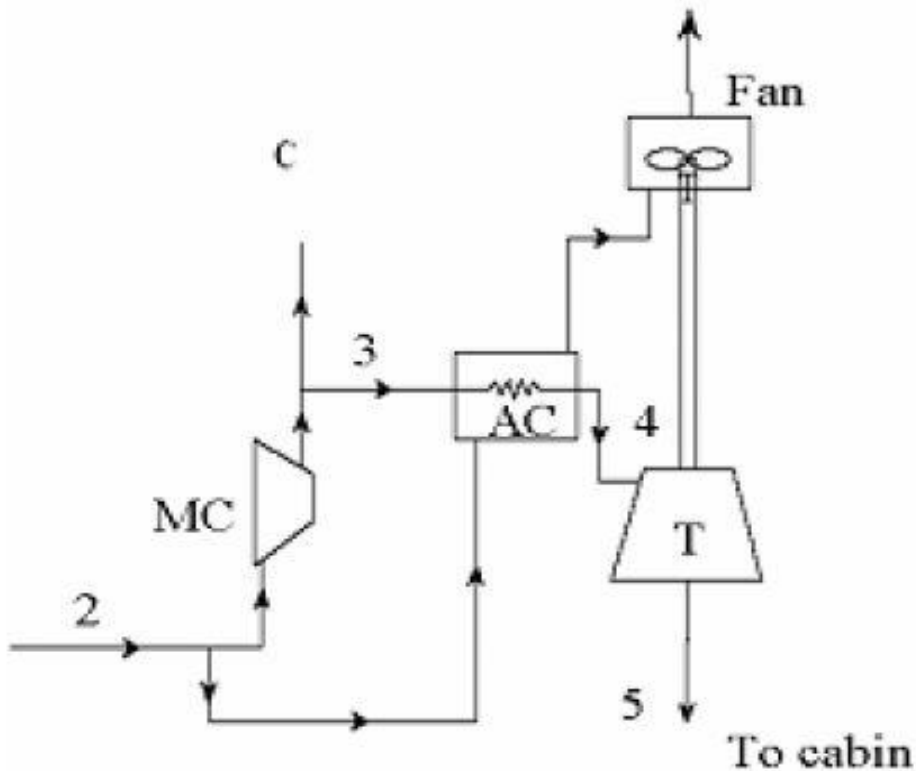

- The outside low pressure and low temperature air (state 1) is compressed due to ram effect to ram pressure (state 2).
- The cold air at state 5 is supplied to the cabin. It picks up heat as it flows through the cabin providing useful cooling effect.
- The power output of the turbine is used to drive the fan, which maintains the required air flow over the air cooler.

- Due to irreversibilities, the actual pressure at the end of ramming will be less than the pressure resulting from isentropic compression.
- The ratio of actual pressure rise to the isentropic pressure rise is called as:

$$\text{Ram efficiency, } \eta_{\text{Ram}} = \frac{P_2 - P_1}{P_{2'} - P_1}$$

- This simple system is good for ground cooling (when the aircraft is not moving) as fan can continue to maintain airflow over the air cooler.

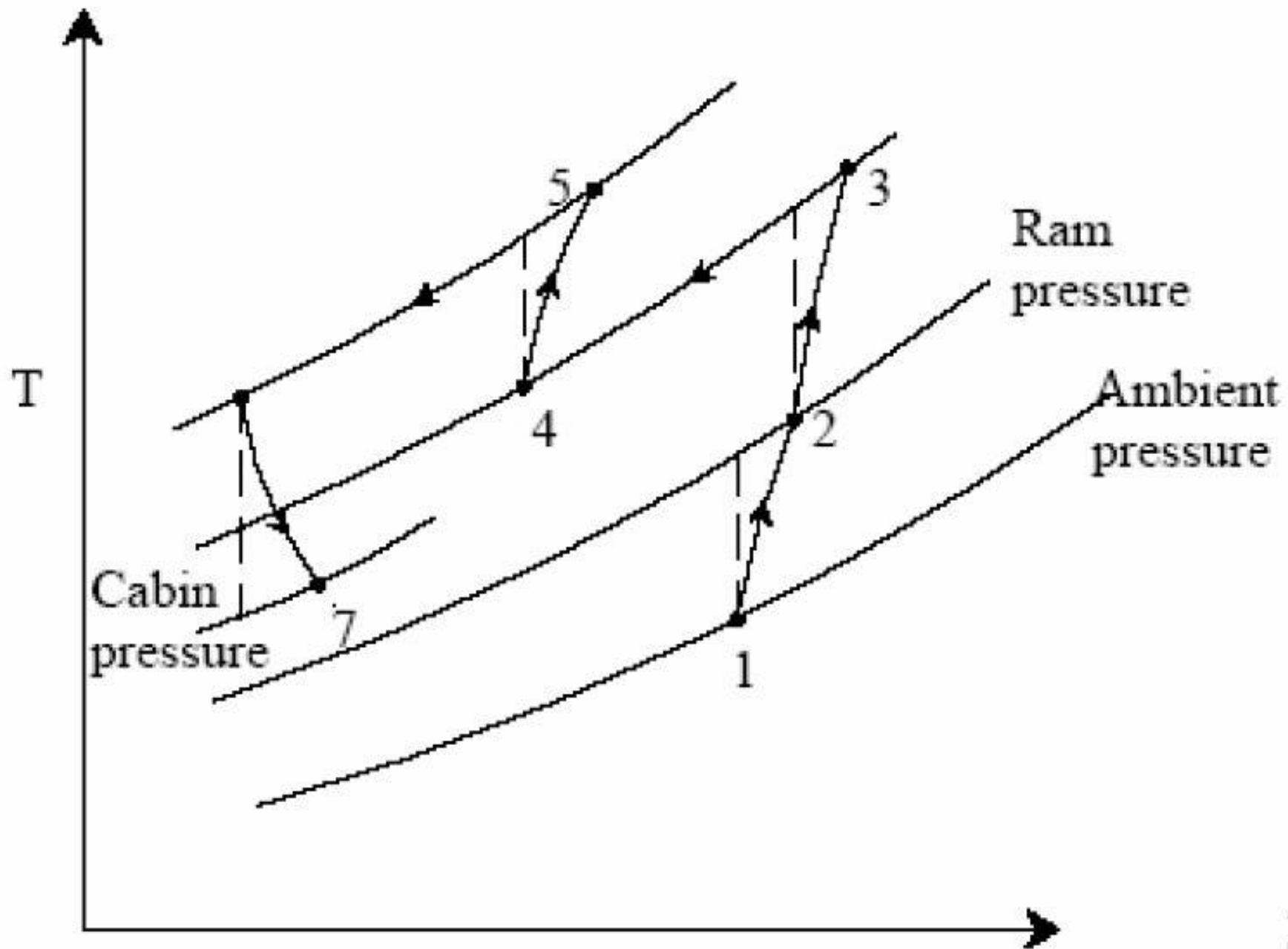

- This system consists of two heat exchangers (air cooler and after cooler).
- It also incorporates a secondary compressor, which is driven by the turbine of the cooling system.
- This system is suitable for high speed aircraft, where in the velocity of the aircraft provides the necessary airflow for the heat exchangers.
- A separate fan is not required, so it is not suitable for ground cooling.

Reduced Ambient System

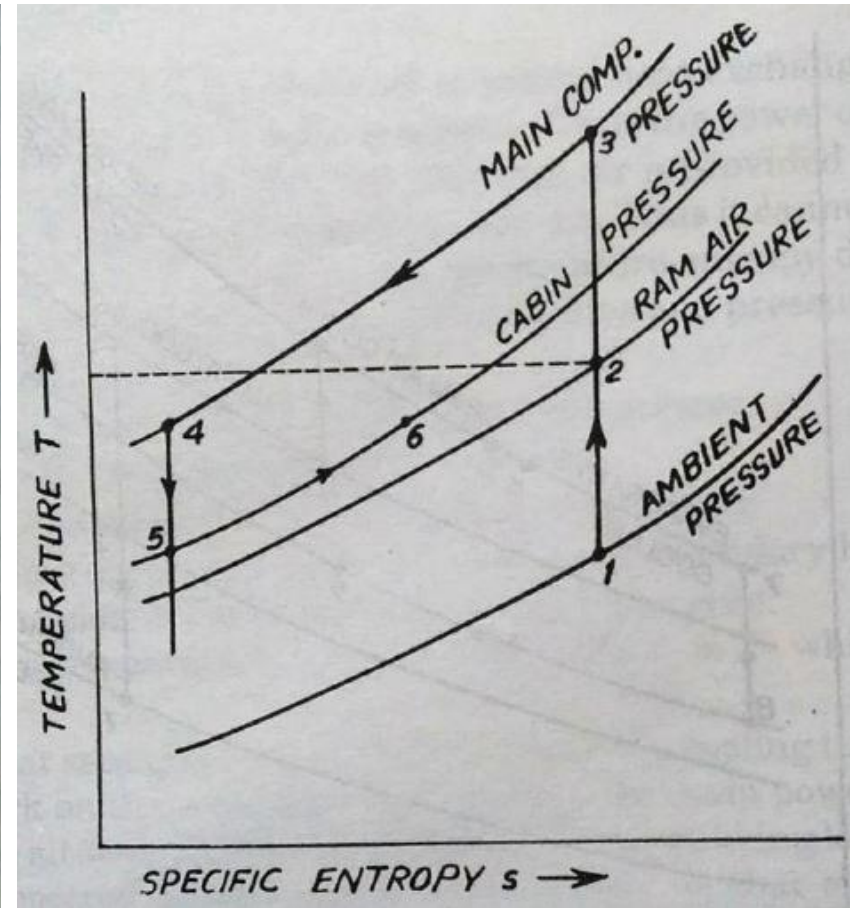
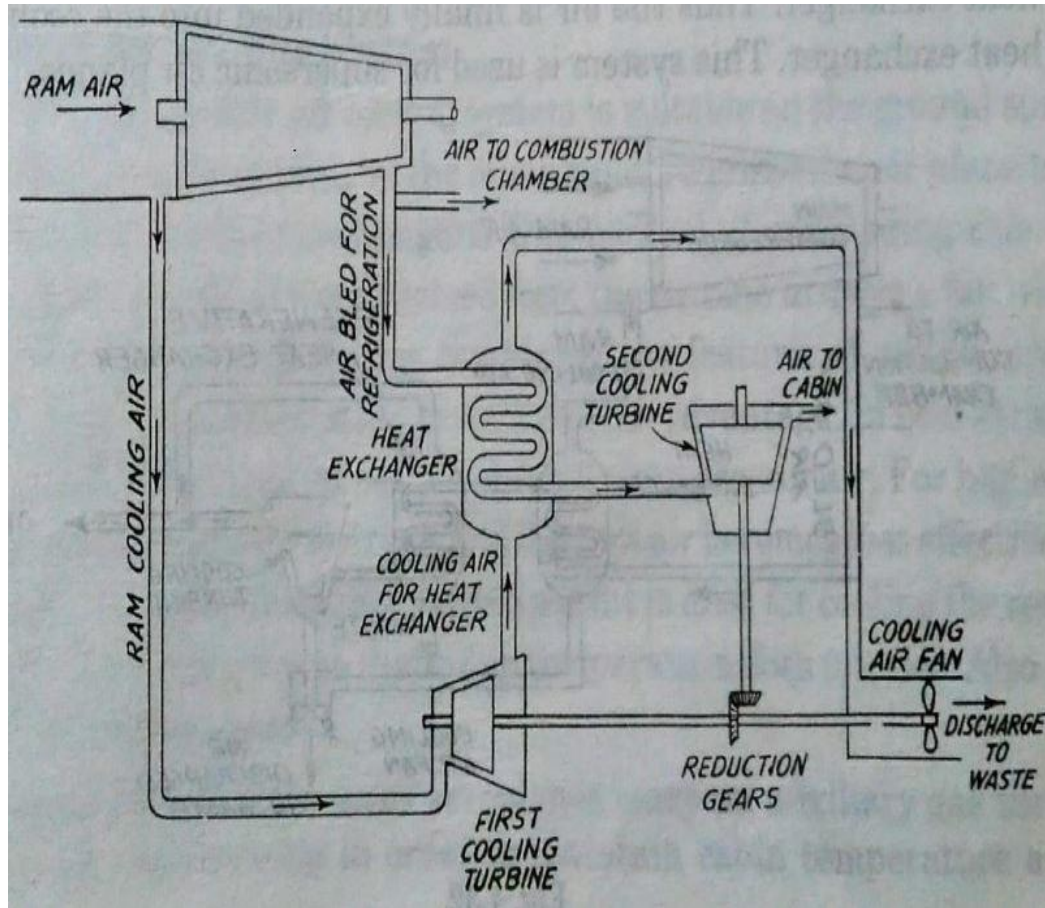

- Used in very high speed aircraft application.
- At very high speed the ram air temperature is too high to work as a good HX coolant.
- So it expands in the first cooling turbine before it used in HX as coolant.
- The temperature T_4 is less than T_2 because the ram air at point 2 is expanded in turbine before it is used for cooling.

Regenerative Cooling System

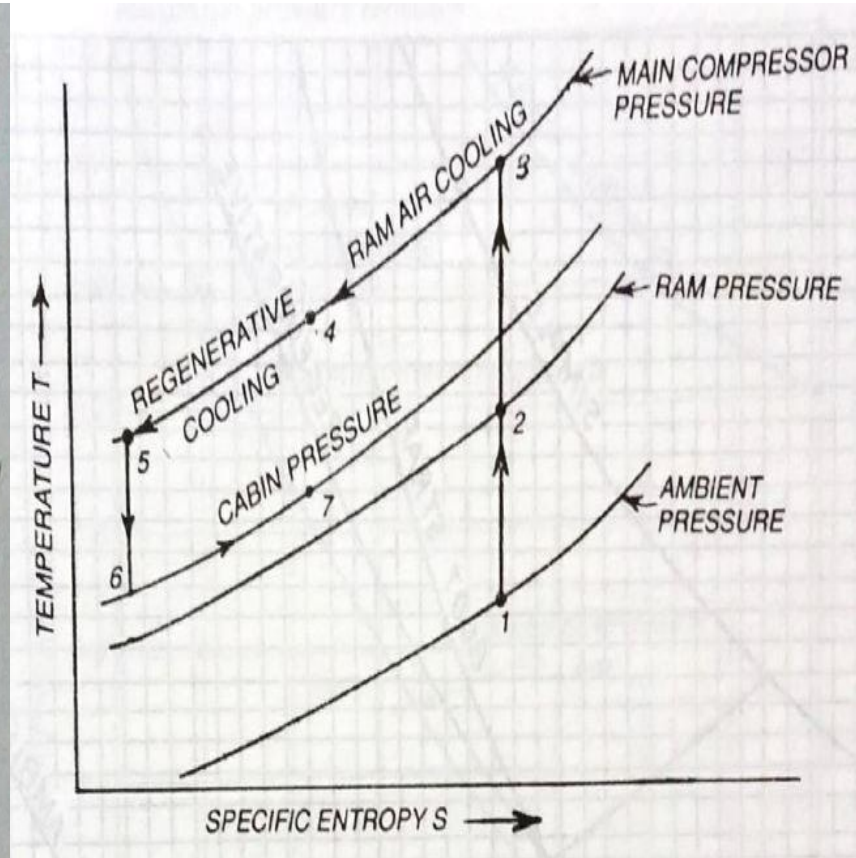
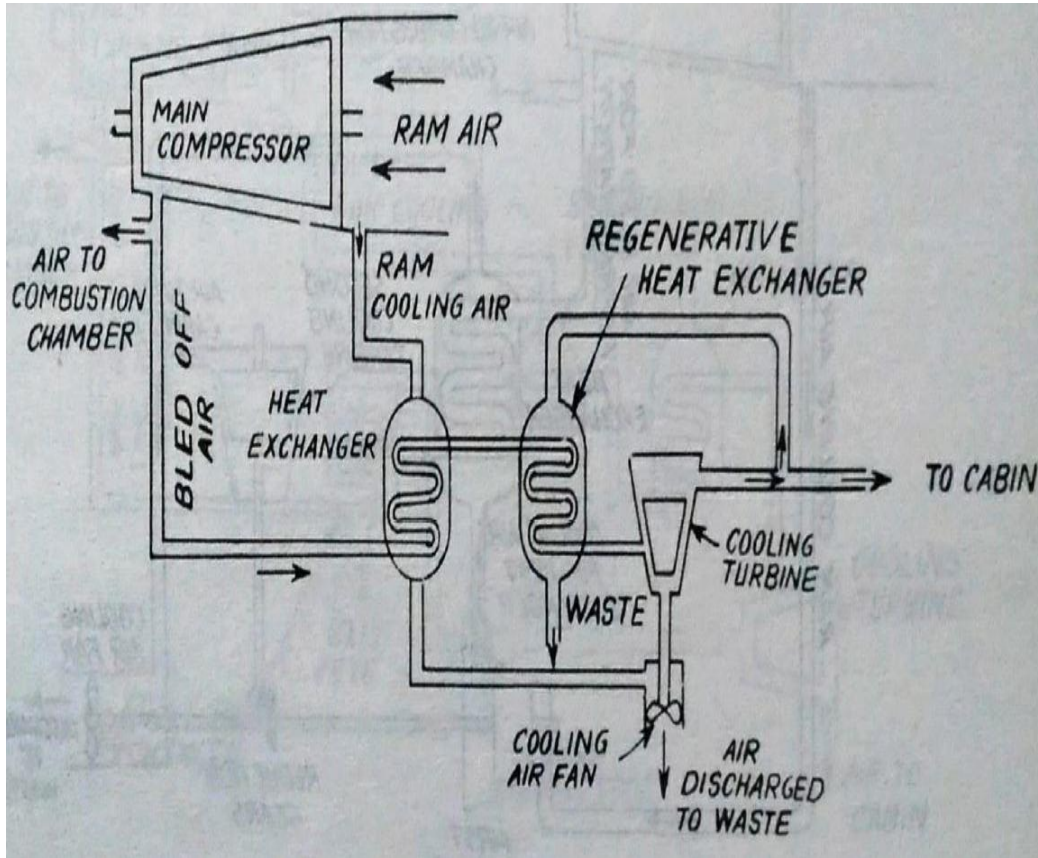

- Also used in high flight speeds ie, supersonic air planes.
- Part of the cooled air to the cabin from the cooling turbine is used to cool the air in the regenerative HX after ram air cooling.
- For higher and higher speed **Bootstrap Evaporative type** is also used.
- In this system additional cooling effect is produced by the evaporation of a refrigerant in the **Evaporator** before passing to the cooling turbine.

Problem 4.8. An air cooling system for a jet plane flying at 6000 m altitude operates on a simple air cycle. The cockpit is to be maintained at 25°C . The ambient air pressure and temperature are 0.5 bar and -5°C . Calculate the stagnation pressure of the air entering the first stage of the main compressor if the ram efficiency is assumed as 80% with the plane speed of 1000 km/hr. Main compressor pressure ratio is 3. Stagnation temperature of the air entering the cooling turbine is 50°C . Pressure drop through heat exchanger is 0.1 bar. Compressor and turbine adiabatic efficiencies are 80%. Pressure in the cockpit is 1 bar. The pressure of air leaving the cooling turbine is 1.05 bar. Cockpit cooling load is 20 ton. $C_p = 1 \text{ kJ/kg}^{\circ}\text{K}$. Neglect frictional losses and assume the air is dry and behaves as a perfect gas with $\gamma = 1.4$.

Determine : (i) The stagnation temperature and pressure of the air entering and leaving the compressor ;

(ii) the temperature of the air leaving the cooling turbine ;

(iii) the air flow rate per minute ;

(iv) power required for pressurisation (with and without ram work) ;

(v) power required for only cooling the cabin (excluding ram work and including turbine work) ;

(vi) COP of the cycle based on compressor work on bled off air ;

(vii) COP of the cycle considering ram work and turbine work.